

A23 - Magnetic

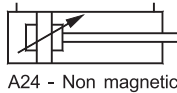

A24 - Non magnetic

AIR CYLINDER

Series A23, A24

Cat No A23, A24 - 01 - 02 - G

Double Acting Cylinders (Square type) Ø32 - 125 mm

As per ISO 15552 / VDMA 24562 standards

Features

- Adjustable cushioning at both ends with elastomer pads
- Wide varieties of mountings as per ISO 15552 / VDMA 24562 standards
- Magnetic and Non magnetic version
- Low Friction (Optional)
- Aluminium profile (square) cylinder barrel
- Magnetic sensor common for all sizes (Refer Magnetic sensor catalogue)
- Optional - High temperature (FKM seals) 150°C max. **
- Optional - Non corrosive Stainless steel piston rod and piston rod lock nut (SS 304) **



Technical Specifications

Cylinder bore Ø	(mm)	32	40	50	63	80	100	125	
Cushion stroke	(mm)	21	23	23	23	28	28	40	
Standard strokes *	(mm)	25, 50, 80, 100, 125, 160, 200, 250, 300, 320, 400, 500						50, 80, 100, 125, 160, 200, 250, 300, 320, 400, 500	
Medium		Compressed air - filtered - lubricated							
Working pressure, bar	A23, A24	0.5 to 10							
	A23L, A24L #	0.3 to 10	0.2 to 10		0.1 to 10		Not available		
Ambient temperature		-10° to +60° C							
Medium temperature	Regular	+5° to +50° C							
	High temperature applications**	+5° to +150°C max.							
Materials of construction		Aluminium, Brass, Steel, Acetal, Polyurethane, Nitrile (Regular), FKM (High temperature)							
Mountings		Basic cylinder, Foot mounting, Front flange, Rear flange, Male clevis, Male clevis (with spherical bearing), Female clevis, Female clevis (King pin), Front trunnion, Rear trunnion,							
Accessories		Clevis foot bracket, Clevis foot bracket (spherical), Wall mounting bracket, Trunnion bracket, Rod end fork, Rod end aligner, Rod end spherical eye							

* - For Non standard or longer stroke cylinders, contact your regional dealer or **JANATICS**

** - Refer Special Ordering number.

- Applicable only for standard strokes (Upto 500mm)

Output force (force in N : 1N = 0.1 kgf)

Cylinder bore Ø (in mm)	Rod Ø (in mm)		Working pressure in bar								
			2	3	4	5	6	7	8	9	10
32	12	Extend	145	217	289	362	434	507	579	651	724
		Retract	124	187	249	311	373	435	498	559	621
40	16	Extend	226	339	452	565	678	792	905	1018	1130
		Retract	190	285	380	475	570	665	760	855	950
50	20	Extend	353	530	706	884	1060	1237	1414	1590	1767
		Retract	297	445	594	742	891	1039	1187	1336	1484
63	20	Extend	561	842	1122	1403	1683	1964	2244	2525	2805
		Retract	505	757	1009	1261	1514	1766	2018	2270	2523
80	25	Extend	905	1357	1809	2262	2714	3167	3619	4072	4524
		Retract	816	1225	1633	2041	2449	2857	3266	3674	4082
100	25	Extend	1414	2120	2828	3534	4241	4948	5655	6362	7069
		Retract	1325	1988	2650	3313	3976	4640	5300	5965	6625
125	32	Extend	2209	3313	4417	5522	6626	7731	8835	9940	11044
		Retract	2064	3096	4128	5160	6192	7224	8256	9288	10320

(Above values have been worked out taking frictional loss into consideration)

AIR CYLINDER

Series A23, A24

Cat No A23, A24 - 01 - 02 - G

Basic cylinder

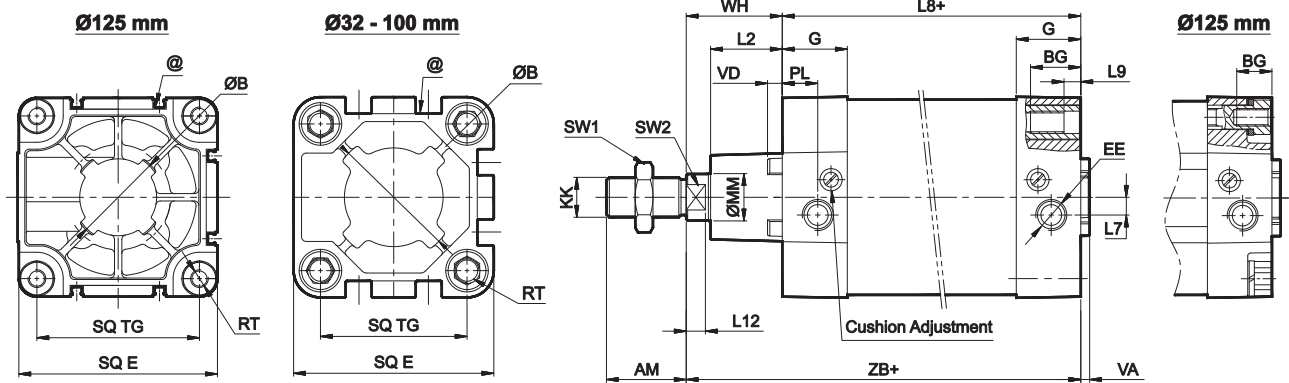

+ Add stroke

Cylinder Bore Ø	KK	AM	MM	SW2	L12	SW1	B e11	VD	VA	L2	E max	G	TG	RT	BG min	EE	PL	L7	WH	Tol	ZB	Tol	L8	Tol	L9	Stroke tol
32	M10x1.25	22	12	10	6	17	30	6	4	18.5	45	25.5	32.5	M6	16	G1/8	13	5	26	±1.3	120	±1	94	±0.6	5	+2 +0
40	M12x1.25	24	16	13	6.5	19	35	6.5	4	20.5	51	29	38	M6	16	G1/4	14.5	5	30		135		105		5	
50	M16x1.5	32	20	16	8	24	40	6.5	4	28	64	29	46.5	M8	16	G1/4	15	7.5	37		143		106		±0.7	
63	M16x1.5	32	20	16	8	24	45	6.5	4	27.5	74	35	56.5	M8	16	G3/8	17	10	37	±1.5	158	±1.1	121	±0.8	6	+2.5 +0
80	M20x1.5	40	25	21	10	30	45	6.5	4	34	94	35	72	M10	16	G3/8	18	14	46		174		128		6	
100	M20x1.5	40	25	21	10	30	55	6.5	4	35	111	38.5	89	M10	16	G1/2	18	10	51		189		138		6	
125	M27x2	54	32	27	13	41	60	10	6	48.5	136	44	110	M12	20	G1/2	20	12	65	±2.2	225	±1.2	160	±1	-	+4 +0

@ - T Groove for magnetic sensor, Refer catalogue series AM4

Foot mounting

+ Add stroke

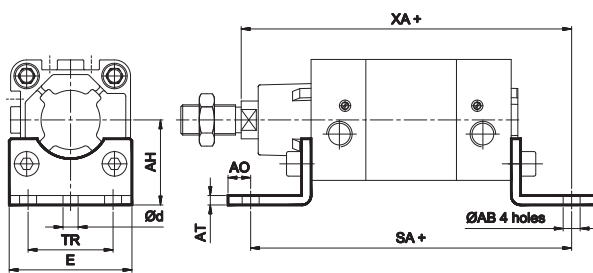

Cylinder Bore Ø	TR ±0.3	AB H14	AH Js15	AO max	AT	E	d*	SA	Tol	XA	Tol	Recommended Bolt size	Ordering no.
32	32	7	32	8	4	46	5.8	142	±1.25	144	±1.25	M6	ML1032
40	36	10	36	10	4	52	7.8	161		163		M8	ML1040
50	45	10	45	12	5	65	7.8	170		175		M8	ML1050
63	50	10	50	12	5	75	7.8	185	±1.6	190	±1.5	M8	ML1063
80	63	12	63	17	6	95	9.8	210		215		M10	ML1080
100	75	14.5	71	19	6	115	11.8	220		230		M12	ML1100
125	90	16.5	90	17	8	140	11.8	250	±2	270	±2	M12	ML0125

* Suitable for reaming

Front flange

+ Add stroke

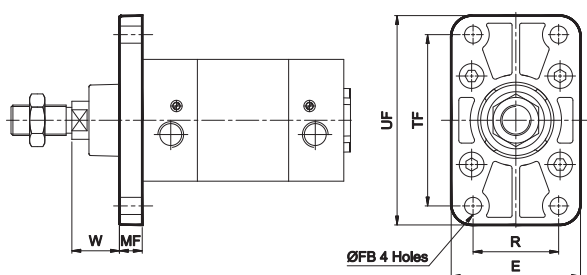

Cylinder Bore Ø	TF ±0.3	R ±0.3	FB H13	MF	UF	E	W	Tol	Recommended Bolt size	Ordering no.
32	64	32	7	10	80	50	16	±1.5	M6	MF1032
40	72	36	9	10	90	55	20		M8	MF1040
50	90	45	9	12	110	68	25		M8	MF1050
63	100	50	9	12	125	78	25	±1.8	M8	MF1063
80	126	63	12	16	155	100	30		M10	MF1080
100	150	75	14	16	185	120	35		M12	MF1100
125	180	90	16	20	211	141	45	±2.5	M12	MF0125

AIR CYLINDER

Series A23, A24

Cat No A23, A24 - 01 - 02 - G

Rear flange

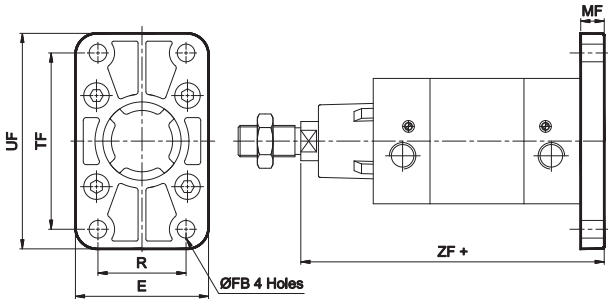

Cylinder Bore Ø	TF ±0.3	R ±0.3	FB H13	MF	UF	E	ZF	Tol	+ Add stroke	
									Recommended Bolt size	Ordering no.
32	64	32	7	10	80	50	130	±1.25	M6	MF1032
40	72	36	9	10	90	55	145		M8	MF1040
50	90	45	9	12	110	68	155		M8	MF1050
63	100	50	9	12	125	78	170	±1.5	M8	MF1063
80	126	63	12	16	155	100	190		M10	MF1080
100	150	75	14	16	185	120	205		M12	MF1100
125	180	90	16	20	211	141	245	±2	M12	MF0125

Male clevis

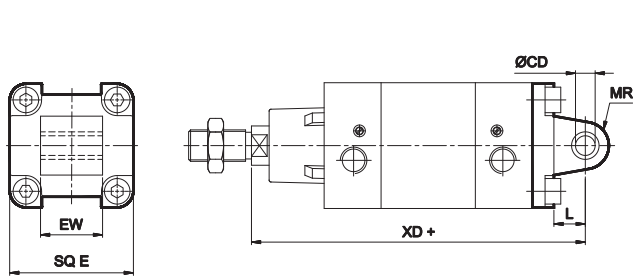

Cylinder Bore Ø	CD H9	EW	Tol	L	MR	E max	XD	Tol	+ Add stroke	
									Ordering no.	
32	10	26	-0.2 -0.6	12	11	45	142	±1.25	MS1032	
40	12	28		15	13	51	160		MS1040	
50	12	32		15	13	64	170		MS1050	
63	16	40	±1.5	20	17	74	190	±1.5	MS1063	
80	16	50		20	17	94	210		MS1080	
100	20	60		25	21	111	230		MS1100	
125	25	70	-0.5 -1.2	30	26	140	275	±2	MS0125	

Male Clevis (with spherical bearing)

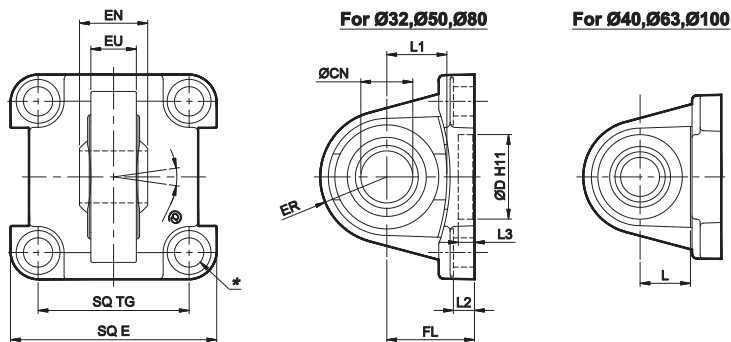

Bore dia	CN H7	EN	EU	L	L1	ER max	SQ E	SQ TG	L2	FL	ØD H11	L3 min	@	Recommended Bolt size *	Ordering no.
32	10	14	10.5	-	13.5	15.5	45	32.5	5.5	22	30	4.5	±4°	M6 x 20	MG1032
40	12	16	12	15.5	-	17.5	51	38	5.5	25	35			M6 x 20	MG1040
50	16	21	15	-	19min	20.5	64	46.5	6.5	27	40			M8 x 20	MG1050
63	16	21	15	19min	-	22.5	74	56.5	6.5	32	45			M8 x 20	MG1063
80	20	25	18	-	24min	27.5	94	72	10	36	45			M10 x 25	MG1080
100	20	25	18	24min	-	29.5	111	89	10	41	55			M10 x 25	MG1100

* Supplied with 4nos. of screws

AIR CYLINDER

Series A23, A24

Cat No A23, A24 - 01 - 02 - G

Female clevis

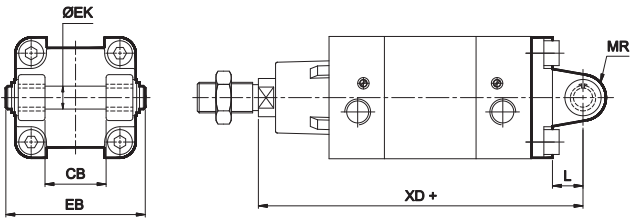

+ Add stroke

Cylinder Bore Ø	EK e8	CB H14	L	MR	EB max	XD	Tol	Ordering no.
32	10	26	12	11	56	142	±1.25	MD1032
40	12	28	15	13	65	160		MD1040
50	12	32	15	13	73	170		MD1050
63	16	40	20	17	86	190	±1.5	MD1063
80	16	50	20	17	106	210		MD1080
100	20	60	25	21	129	230		MD1100
125	25	70	30	26	148	275	±2	MD0125

Female clevis (King pin)

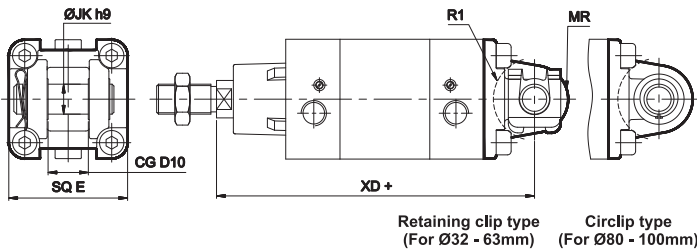

+ Add stroke

Cylinder bore Ø	JK h9	CG D10	R1	MR max	SQ E	XD	Tol	Ordering no.
32	10	14	17	11	45	142	±1.25	MK1032
40	12	16	20	13	51	160		MK1040
50	16	21	22	18	64	170		MK1050
63	16	21	25	18	74	190	±1.6	MK1063
80	20	25	30	22	94	210		MK1080
100	20	25	32	22	111	230		MK1100
125	30	37	42	30	136	275	±2	MK0125

Front trunnion

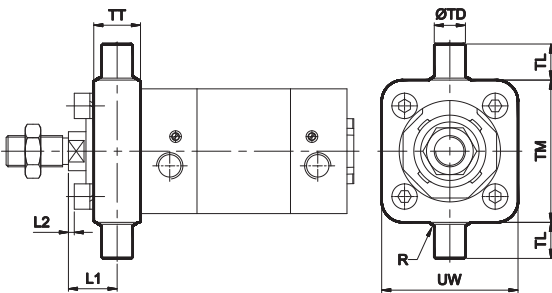

+ Add stroke

Cylinder Bore Ø	TD e9	TL h14	TM h14	UW	TT	R	L1	Tol	L2 approx	Ordering no.
32	12	12	50	48	16	1	18	±1.5	2	MT1032
40	16	16	63	55	22	1.5	19		0	MT1040
50	16	16	75	70	24	1.6	25		3	MT1050
63	20	20	90	86	28	1.6	23	±1.8	-1	MT1063
80	20	20	110	110	32	1.6	30		1.8	MT0080
100	25	25	132	135	40	2	31		-1.2	MT0100
125	25	25	160	155	44	2	43	±2.5	6.5	MT0125

Rear trunnion

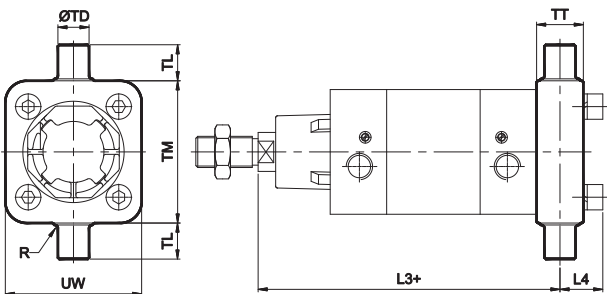

+ Add stroke

Cylinder Bore Ø	TD e9	TL h14	TM h14	UW	TT	R	L3	Tol	L4 approx	Ordering no.
32	12	12	50	48	16	1	128	±1.5	16	MT1032
40	16	16	63	55	22	1.5	146		19	MT1040
50	16	16	75	70	24	1.6	155		22	MT1050
63	20	20	90	86	28	1.6	172	±1.8	24	MT1063
80	20	20	110	110	32	1.6	190		29	MT0080
100	25	25	132	135	40	2	209		33	MT0100
125	25	25	160	155	44	2	247	36.5	MT0125	

AIR CYLINDER

Series A23, A24

Cat No A23, A24 - 01 - 02 - G

Accessories for Air Cylinder series A23, A24

Clevis foot bracket

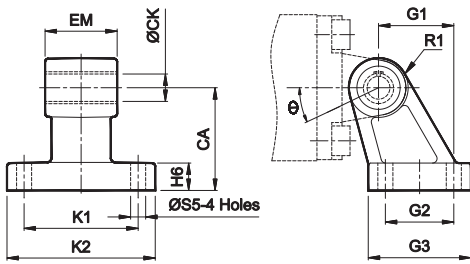

Cylinder Bore Ø	K1 Js14	G2 Js14	S5 H13	CA Js15	CK H9	EM	Tol	G1 Js14	H6	R1 max	K2	G3	θ°	Recommended Bolt size	Ordering no. @
32	38	18	6.6	32	10	26	-0.2 -0.6	21	8	10	51	31	10	M6	AA1032
40	41	22	6.6	36	12	28		24	10	11	54	35	15	M6	AA1040
50	50	30	9	45	12	32		33	12	13	65	45	15	M8	AA1050
63	52	35	9	50	16	40		37	12	15	67	50	15	M8	AA1063
80	66	40	11	63	16	50		47	14	15	86	60	15	M10	AA1080
100	76	50	11	71	20	60	55	15	19	96	70	15	M10	AA1100	
125	94	60	14	90	25	70	-0.5 -1.5	70 ±0.2	20	23.5	124	90	-	M12	AA0125

@ Adaptable to cylinder with female clevis

Clevis foot bracket (with spherical bearing)

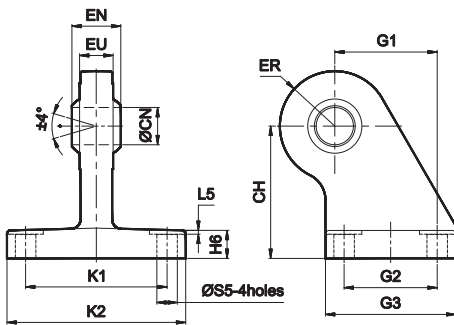

Cylinder bore Ø	K1 Js14	G2 Js14	S5 H13	CH Js15	CN H7	EU max	G1 Js14	H6	ER max	K2 max	G3	EN -0.1	L5	Ordering no. @
32	38	18	6.6	32	10	10.5	21	10	16	51	31	14	1	AB1032
40	41	22	6.6	36	12	12	24	10	18	54	35	16	1	AB1040
50	50	30	9	45	16	15	33	12	21	65	45	21	1	AB1050
63	52	35	9	50	16	15	37	12	23	67	50	21	1	AB1063
80	66	40	11	63	20	18	47	14	28	86	60	25	2	AB1080
100	76	50	11	71	20	18	55	15	30	96	70	25	2	AB1100

@ Adaptable to cylinder with female clevis

Clevis foot bracket (with spherical bearing)

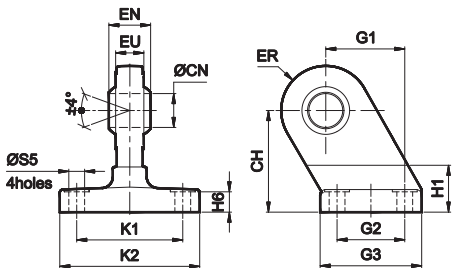

Cylinder bore Ø	K1 Js14	G2 Js14	S5 H13	CH Js15	CN H7	EU max	G1 Js14	H6	ER max	K2	G3	EN -0.1	L5	H1 max	Ordering no. @
125	94	60	14	90	30	25	70	20	40	124	90	37	2	50	AB1125

@ Adaptable to cylinder with female clevis (King pin)

Wall mounting bracket

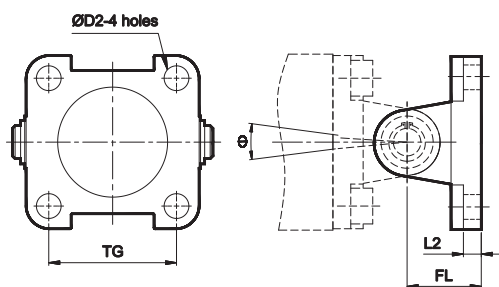

Cylinder bore Ø	TG	D2	L2	FL	θ°	Recommended Bolt size	Ordering no. @	Ordering no. #
32	32.5	6.6	5.5	22	90	M6	AV1032	AW1032
40	38	6.6	5.5	25	90	M6	AV1040	AW1040
50	46.5	9	6.5	27	90	M8	AV1050	AW1050
63	56.5	9	6.5	32	90	M8	AV1063	AW1063
80	72	11	10	36	60	M10	AV1080	AW1080
100	89	11	10	41	60	M10	AV1100	AW1100
125	110	13	10	50 ±0.2	80	M12	AV0125	AW0125

@ Adaptable to cylinder with male clevis
Adaptable to cylinder with female clevis

AIR CYLINDER

Series A23, A24

Cat No A23, A24 - 01 - 02 - G

Trunnion bracket

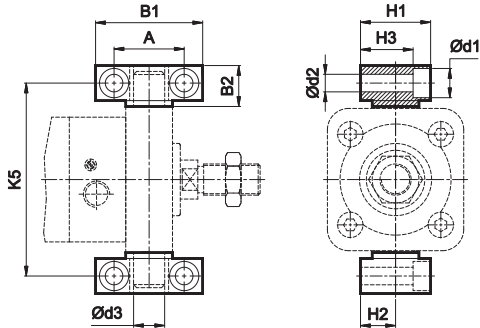

Cylinder bore Ø	B1	B2	A	d1	d2 H13	d3 H9	H1	H2	H3	K5 Js14	Ordering no.
32	46	18	32 ±0.2	11	6.6	12	30	15 ±0.1	23	71	AT032
40	55	21	36 ±0.2	15	9	16	36	18 ±0.1	27	87	AT040
50	55	21	36 ±0.2	15	9	16	36	18 ±0.1	27	99	AT040
63	65	23	42 ±0.2	16.5	11	20	40	20 ±0.1	29	116	AT063
80	65	23	42 ±0.2	16.5	11	20	40	20 ±0.1	29	136	AT063
100	75	28.5	50 ±0.2	20	14	25	50	25 ±0.1	37	164	AT100
125	75	28.5	50 ±0.2	20	14	25	50	25 ±0.1	37	192	AT100

Rod end Fork (ISO 8140)

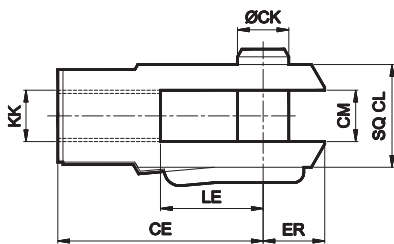

Cylinder bore Ø	KK	CE	CK f 8	CM B12	LE	ER max	CL	Ordering no.
32	M10 x 1.25	40	10	10	20	16	20	AF010
40	M12 x 1.25	48	12	12	24	19	24	AF012
50 / 63	M16 x 1.5	64	16	16	32	25	32	AF016
80 / 100	M20 x 1.5	80	20	20	40	32	40	AF020
125	M27 x 2	110	30	30	55	45	55	AF030

Rod end Aligner

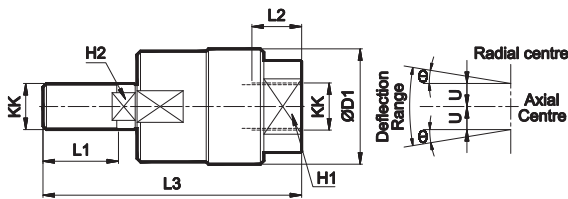

Cylinder bore Ø	KK	L1	L2	L3	H1	H2	D1	U	± 0°	Ordering no.
32	M10 x 1.25	20	14	65	17	8	28	0.75	5	AR010
40	M12 x 1.25	22	18	75	19	10	32	1	5	AR012
50 / 63	M16 x 1.5	25	22	91	27	13	41	1	5	AR016
80 / 100	M20 x 1.5	30	28	112	32	16	50	1.5	5	AR020

Rod end spherical eye (ISO 8139)

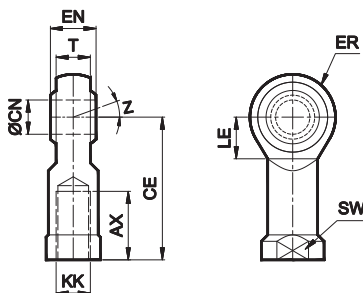

Cylinder bore Ø	KK	CN H9	T	EN h12	CE	LE min	ER max	AX	SW	Z	Ordering no.
32	M10 x 1.25	10	10.5	14	43	15	14	20	17	13°	AP010
40	M12 x 1.25	12	12	16	50	17	16	22	19		AP012
50 / 63	M16 x 1.5	16	15	21	64	22	21	28	22	15°	AP016
80 / 100	M20 x 1.5	20	18	25	77	26	25	33	30/32		AP020
125	M27 x 2	30	25	37	110	36	35	51	41		AP027

AIR CYLINDER

Series A23, A24

Cat No A23, A24 - 01 - 02 - G

How to order

A		24		Optional		040		050		D		Optional	
Model		Type		Piston Ø (mm)		Stroke (mm)		Mountings		Special Cylinders			
23	Magnetic cylinder	L	Low Friction Cylinder	032	- Ø 32	025	- 25	O	- Basic	H	- High temp		
24	Standard cylinder			040	- Ø 40	050	- 50	L	- Foot Mounting	S	- SS piston rod		
				050	- Ø 50	080	- 80	F	- Front Flange	Note: Low friction cylinder not available in High temp model.			
				063	- Ø 63	100	- 100	R	- Rear Flange				
				080	- Ø 80	125	- 125	S	- Male Clevis				
				100	- Ø 100	160	- 160	G	- Male Clevis (with spherical bearing)				
				125	- Ø 125	200	- 200	D	- Female Clevis				
						250	- 250	K	- Female Clevis (King pin)				
						300	- 300	M	- Rear Trunnion				
						320	- 320	N	- Front Trunnion				
						400	- 400						
						500	- 500						

Note: Ø125 mm Low friction cylinder not available

Note

For details of Accessories for Magnetic sensor, refer catalogue **Series AM4** (Page no. 1a.1.1)

Example:

Ordering no. for standard cylinder with 40 dia bore, 50 mm stroke with female clevis mounting: **A24 040 050 D**

Note:







If ordered as 40 dia, 50 mm stroke cylinder, Basic cylinder **A24 040 050 O** will be supplied.

If ordered as 40 dia, 50 mm stroke cylinder, Low friction cylinder **A24L 040 050 O** will be supplied.

For repeat order when the details are taken from cylinder nameplate, mention the mounting style separately.

For ordering **Accessories** refer corresponding tables for ordering numbers.

For ordering individual **Mounting** kits (If needed separately) the order numbers are as below

Cylinder bore Ø	Foot mounting*	Front / Rear flange*	Male clevis*	Female clevis*	Front / Rear trunnion*	Female clevis (King pin)*
						
32	ML1032	MF1032	MS1032	MD1032	MT1032	MK1032
40	ML1040	MF1040	MS1040	MD1040	MT1040	MK1040
50	ML1050	MF1050	MS1050	MD1050	MT1050	MK1050
63	ML1063	MF1063	MS1063	MD1063	MT1063	MK1063
80	ML1080	MF1080	MS1080	MD1080	MT0080	MK1080
100	ML1100	MF1100	MS1100	MD1100	MT0100	MK1100
125	ML0125	MF0125	MS0125	MD0125	MT0125	MK0125

* Supplied with 4nos. of screws

For your special requirements of cylinders or for further informations contact your regional dealer or **JANATICS**

Subject to change